

Wolffpac Technologies



Bally™/Stern™ 7-digit Display Kit (Ver. 2)



Assembly Instructions

Wolffpactech.com

When assembled, this display will replace the Bally/Stern 7-digit display used on many solid-state pinball machines from 1980 to 1986. For the complete list of compatible machines, see the list at the end of these instructions.

Tools:

Soldering iron - A small to medium power soldering iron of 25-50 watts with a small tip, preferably temperature controlled, is recommended.

Wire cutters - A set of diagonal or wire cutters intended for cutting electronic component leads.

Alcohol –Isopropyl Alcohol, Denatured Alcohol or Flux Remover to be used for cleaning the board after assembly.

Solder - Use only solder designated for electronic component assembly. Either lead-based or lead-free flux-core solder are both acceptable.

→ Use of solid core, acid core or plumbing solder is not acceptable and will void the warranty. ←

All soldering should be done on the bottom (non-printed) side of the boards. This kit uses “old school” through-hole components requiring only basic soldering skills to assemble. However, if you have never soldered before or are unsure of your skill level, it is recommended that you first practice soldering on a scrap board before beginning to assemble this kit. There are many references on the internet which can help you learn how.



Caution - Warning







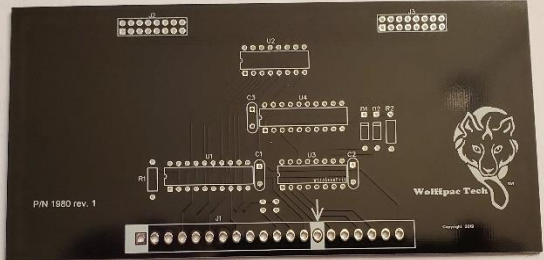

Solder melts at around 400°F to 600°F (200°C to 300°C). Remember to use care when soldering as both the soldering iron and solder are extremely hot and can produce serious burns. Make sure that you use an appropriate work surface since molten solder may drip and hot solder and components may damage or burn many materials.

Eye protection is recommended as solder can splash and component leads may fly when cut.

We are not responsible for any damage or injury as a result of assembling this kit.

Remember: Solder and components will remain very hot for several minutes after soldering.

Parts List:

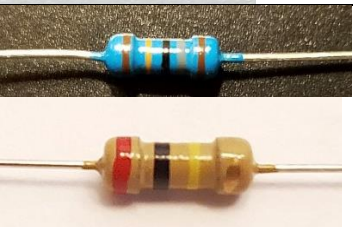
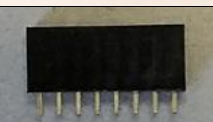
Part Description	Ref	Qty	
Printed Circuit Board 'A', Marked: P/N 1980		1	
Printed Circuit Board 'B', Marked: P/N 1970		1	
IC, Marked: 74HCT244	U1	1	
IC, Marked: ULN2003	U2	1	
IC, Marked: CD4543	U3	1	
IC, Marked: 74ACT541	U4	1	
Capacitor 0.1uF, Marked: 104	C1 - C3	3	
Diode Marked: iN4148	D1, D2	2	
Resistor, 180K, Marked: Brown-Gray-Black-Yellow-Brown Or 200K, Marked: Red-Black-Yellow-Gold	R1, R2	2	
Female Header, 2x8 Position Straight	J2-J3	2	





Male Header, 2x8 Position Right Angle	J4, J5	2	
7-segment or 14-Segment LED Display	DS	7	
Male Header, 20 Positions Straight (Shipped as 2 pieces)	J1	1	
Foam Bezel		1	
Resistor, See table 1 for value and marking based on the color of the LED digits in your kit:	See Table 1	8	

Table 1, Resistor value (P/N 1970: R10-R17)		
LED display color	Value	Marking
Orange	120 Ohm	Brown-Red-Black-Black-Brown
Red	150 Ohm	Brown-Green-Black-Black-Brown
Blue	100 Ohm	Brown-Black-Black-Black-Brown
Green	150 Ohm	Brown-Green-Black-Black-Brown
White	100 Ohm	Brown-Black-Black-Black-Brown

Start Here:

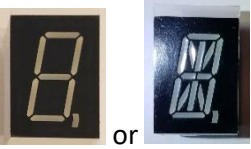
Before starting, check the components received against the parts list on page two. If any components are missing, or you have any questions regarding these assembly instructions please contact Wolffpac Tech at 'wolffpactech@gmail.com'.

If you have any problems with the display after assembly, you may contact Wolffpac Tech at 'wolffpactech@gmail.com'. If you need to return the display for repair, we will provide a pre-paid return label. Any problem found to be due to defective components will be repaired free of charge within 1 year of purchase. Any problem found to be due to assembly error or damage will be charged for postage and the cost of any components which need to be replaced.

Control Board 'A':

Step 1: Start with the larger PC Board 'A' (marked P/N 1980):

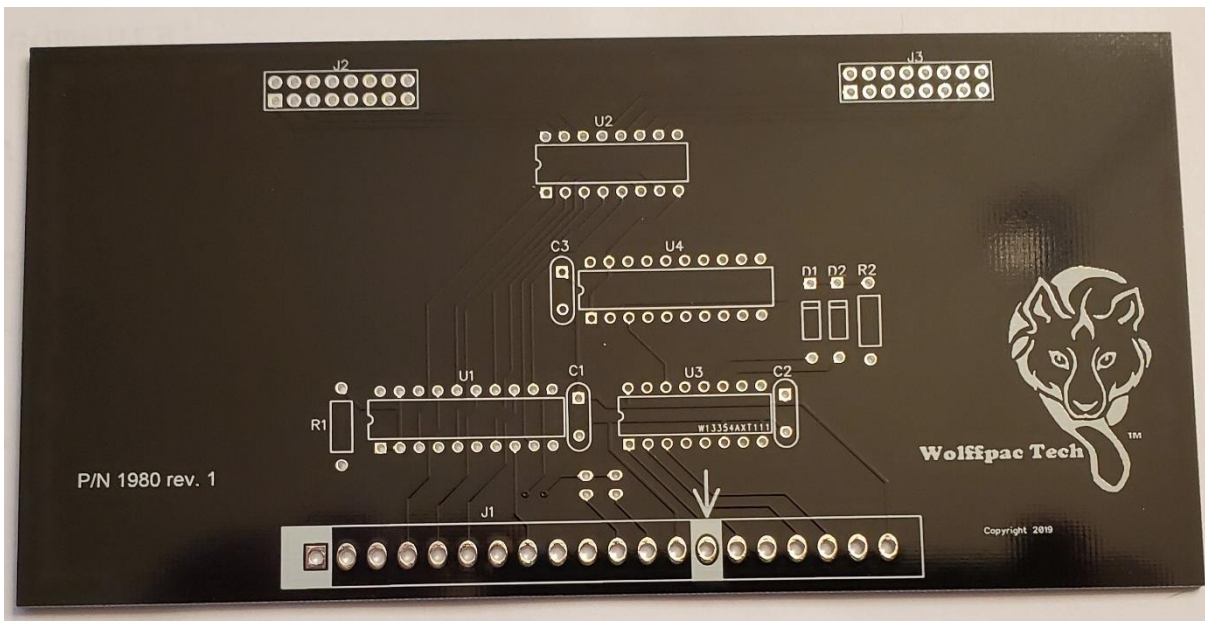

Insert U1 (74HCT244) into the board from the top side (the side with the lettering) so that one pin goes through each hole at the location labeled 'U1'. Each chip is marked with a 'U'-shaped notch on one of the short ends:



This end should line up with the notch printed on the PC board. You may find that you have to bend the legs of the chip slightly in order to get both rows to line up with the holes in the board. You can do this with needle nose pliers or by laying the chip on its side with the pins of one side on a hard surface pointing away from you and gently pressing down and away on the body of the chip. Be careful not to bend the pins too far. Once inserted, you can bend the pins at the corners from the bottom in order to hold the chip in place.

Make sure that all of the pins from the chip are completely inserted through the holes in the board before soldering in place from the bottom.

Step 2. Repeat for U2 (ULN2003), U3 (CD4543) and U4 (74ACT541).

Step 3: Locate resistors R1 and R2. Bend the leads approximately 90° near the body of the resistor so that it forms a 'U' shape. Do not force the bend any closer than it will go with light finger pressure or you may damage the component. Insert the resistor into the board at the position marked R1 on the board. The direction does not matter. The leads should line up easily with the holes on the board. Once inserted through the board, bend the leads slightly from the bottom to hold the resistor against the board. Solder from the bottom. Trim the excess leads from the bottom of the board with diagonal cutters leaving about 1/16 inch.

Repeat for R2.

Step 4: Locate diodes D1-D2. Bend the leads of one diode approximately 90° near the body of the diode so that it forms a 'U' shape. Do not force the bend any closer than it will go with light finger pressure or you may damage the component. Insert the diode into the board at the position marked D1 on the board. The diode must be inserted so that the end marked with a black line is towards the end marked on the circuit board with a line and a square solder pad. Bend the leads slightly from the underside of the board to hold in place and solder from the bottom. Trim the excess leads to about 1/16 inch. Repeat for D2.

Step 5: Locate capacitors C1 – C3. Insert one capacitor at the positions marked C1 on the board. The direction of these component does not matter. Bend the leads slightly from the bottom of the board to hold in position and solder in place. Trim the excess lead length to about 1/16 inch. Repeat for C2 and C3.

Step 6: Locate headers J2 and J3. Insert one of the black female 2x8 headers into the position marked J2. Make sure that all pins are correctly inserted through the holes.

It is very important that J2 and J3 are seated flush against the top of the board. For this reason, it is recommended that you solder only one pin on each end of the header until you can confirm that the connector is seated flush and square with the top surface of the board. If not, you can reheat the pin while pressing on the connector from the opposite side. Solder the remaining pins in place. Repeat for J3.

Step 7: J1. Connector J1 is shipped in two pieces. Note that one of the pieces is missing a pin. The two halves of the connector are installed with the missing pin lined up with the position marked with a white square and the arrow.

The connectors are installed with the friction retainer towards the outer edge of the board. The two pieces must be in line with each other. For this reason, it is recommended that you initially solder only one pin on each of the two pieces. If needed, remelt the solder while pressing on the connector to ensure it is flush with the top side of the board and that the two halves are in line with each other. Once you have confirmed that the connectors are in the correct position, solder the remaining pins.

Caution: While soldering, the exposed pins on the top side of the board will get extremely hot! Avoid getting burned!

Display Board 'B':

Step 1: Your kit will come with a PC board 'B' marked P/N 1970:

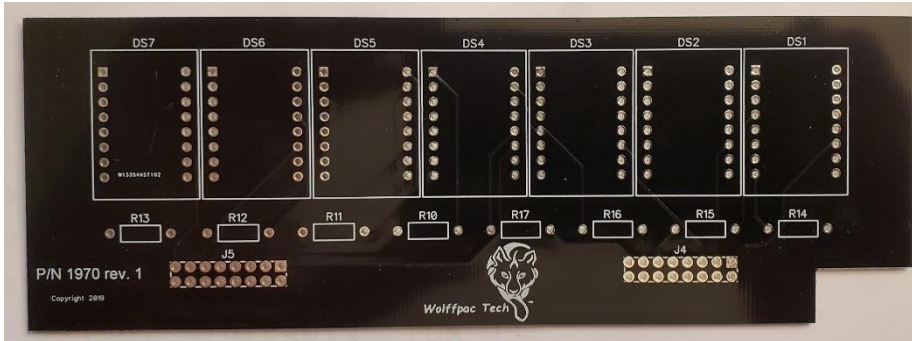

Step 2: Locate resistors R10-R17.

Gently bend the leads of each resistor into a 'U' shape. Insert through the board at the marked positions. Direction does not matter. Bend the leads slightly from the bottom to hold the components against the top surface and solder from the bottom. Trim the excess lead length, leaving about 1/16 inch on the bottom of the board.

Step 3: Locate J4 and J5. Insert one of the right-angle headers into the position marked J4. The end with the right-angle bend is inserted into the board. It is very important that the connectors are installed so that the black plastic is flush and perpendicular against the board and the pins on the opposite end of the connector are parallel with the PC board. It is recommended that you solder one pin on each end of the connector until you can confirm that they are correctly aligned before soldering the remaining pins. Repeat for J5.



Step 4: 7-segment or 14-Segment LED's.

Your kit will be supplied with either 14-segment LED's or 7-segment LED's. They are functionally identical. If you have 7-segment LEDs, some of the PCB holes will not be used. The LED's are installed in positions DS1-DS7.

Install one 7-segment or 14-segment LED in each position. Ensure that the component is installed with the comma (',') towards J4 and J5 and that all of the pins are correctly seated in the holes. Lay the board face down and solder one pin in each row. Inspect to ensure that the display is seated flush with the PC board. If not, reheat the pin while pressing on the display from the front of the board. Once the LED is correctly seated, solder the remaining pins. Repeat for the remaining 6 LED displays.

Final Assembly

Step 1. Wipe or rinse the board with Isopropyl Alcohol, Denatured Alcohol, Flux Remover or water depending on the type of solder used to remove the solder flux residue.

Step 2. When the board is completely dry, peel the clear plastic protective film from the front surface of each LED display.

Step 3. Remove the paper backing covering the adhesive from the foam bezel. Carefully line the openings with the LEDs and install as shown below.

Note: The adhesive is very aggressive. Be careful when handling the bezel after removing the paper backing to avoid sticking it to something you didn't intend!

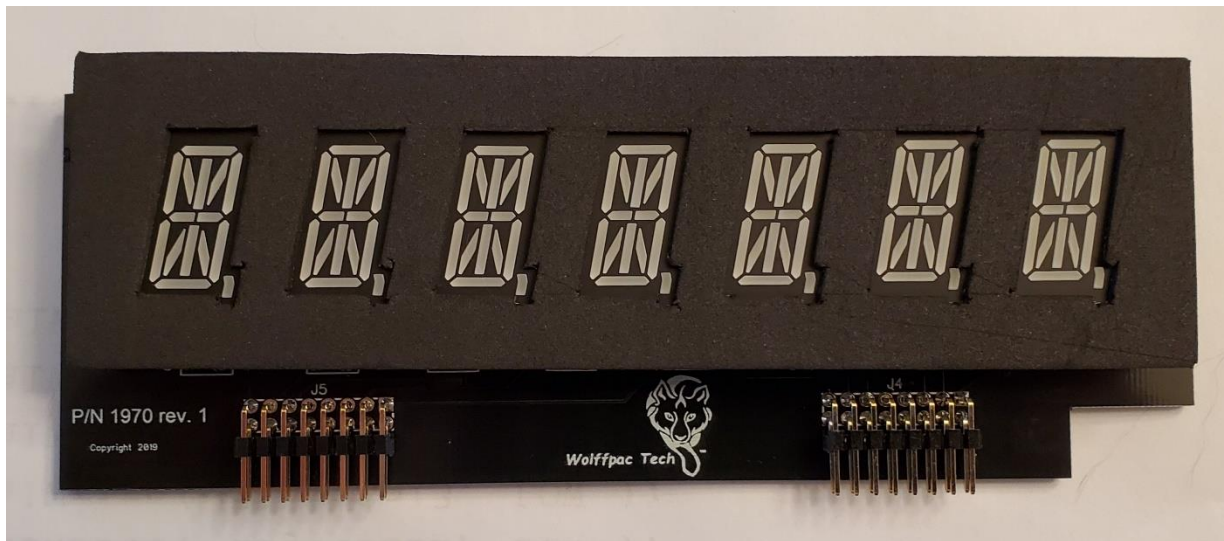

Step 4. Insert board 'B' (1970) with the LED's into the 'A' board (1980). Line the pins from J4 and J5 with the holes in J2 and J3 with the LEDs pointing outwards. Press down firmly. About 1/8" of board B should slide behind J2 and J3.

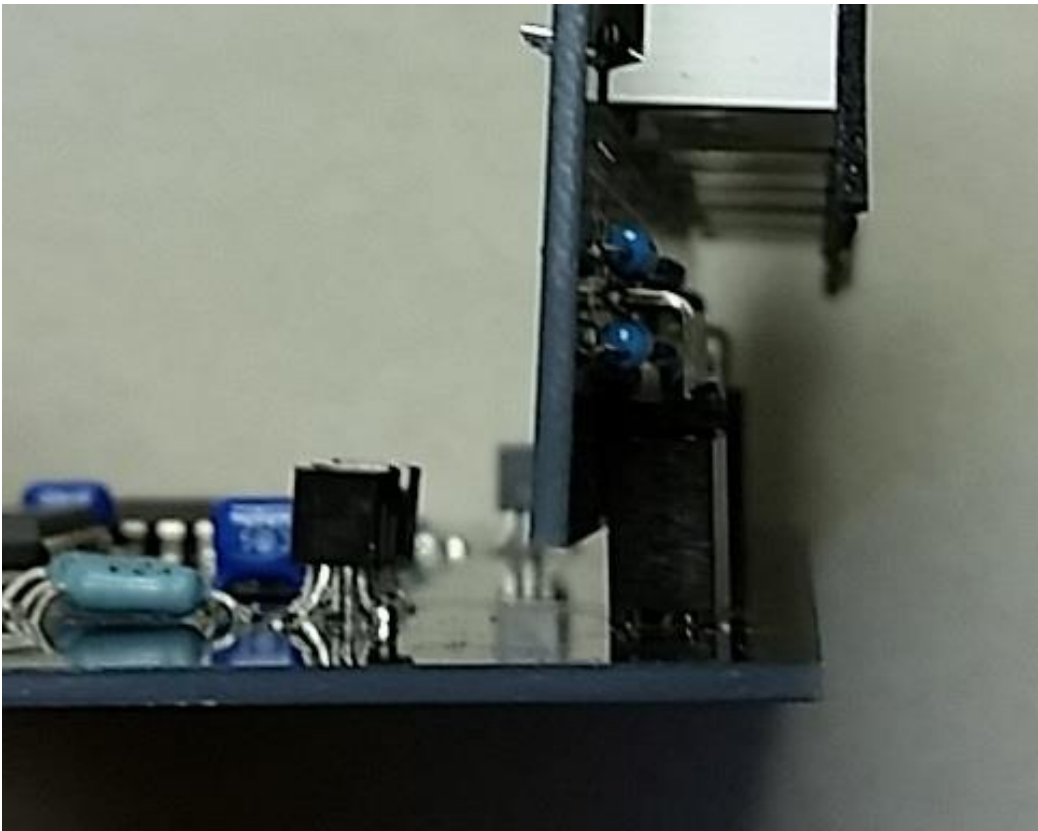

Step 5. With the power off, install in your pinball machine. Note that the arrow on PC board 'A' J1 points to the location of the 'key' position for the connector. If the connectors supplied at J1 totaled less than 20 positions, the pin location marked with a white square will not attach to the connector from your pinball machine.

Apply power and enjoy!

This is believed to be an accurate list of machines with displays compatible with this replacement. Since we are unable to test this board in every configuration, we take no responsibility for any errors. However, we do welcome feedback as to any errors that are found so that we can update this list.

Note: Most pinball machines which use 7-digit score displays use a 6-digit display for the credit. Please see our 6-digit kit if you need a replacement.

Bally - P/N: AS-2518-58 :

- Skateball, 9/80
- Frontier, 11/80
- Xenon, 11/80
- Flash Gordon, 2/81
- Eight Ball Deluxe, 4/81
- Fireball II, 6/81
- Fathom, 8/81
- Medusa, 9/81
- Centaur, 10/81
- Elektra, 12/81
- Vector, 2/82
- Spectrum, 6/82
- Speakeasy, 8/82
- Speakeasy 4, 8/82
- Rapid Fire, 4/82
- Mr & Mrs Pacman, 4/82
- Eight Ball Deluxe Limited Edition, 10/82
- BMX 1/83
- Centaur II, 5/83

Bally – Midway

- X's & O's, 2/84
- Kings of Steel, 3/84
- Black Pyramid, 7/84
- Spy Hunter, 10/84
- Eight Ball Champ, 8/85
- Eight Ball Deluxe, 11/84
- Fireball Classic, 12/84
- Cybernaut, 5/85
- Beat The Clock 11/85
- Lady Luck, 3/86

Stern - P/N A-645 :

- Big Game 3/80
- Catacomb 10/81
- Cheetah 6/80

- Dragonfist 1/82
- Flight 2000 10/80
- Freefall 1/81
- Iron Maiden 10/81
- Lightning 3/81
- Nine Ball 12/80
- Orbitor 12/82
- Quicksilver 6/80
- Seawitch 5/80
- Split Second 8/81
- Viper 12/81

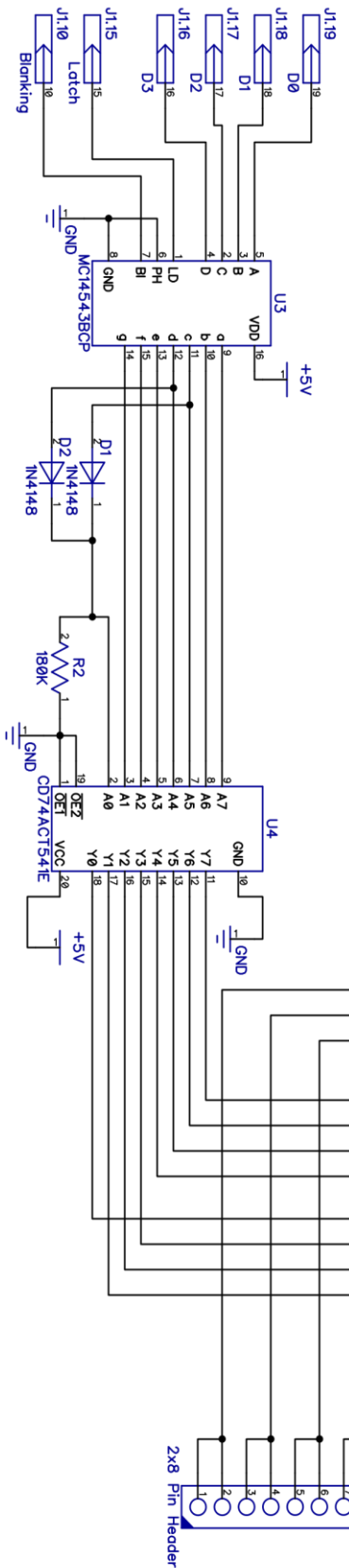
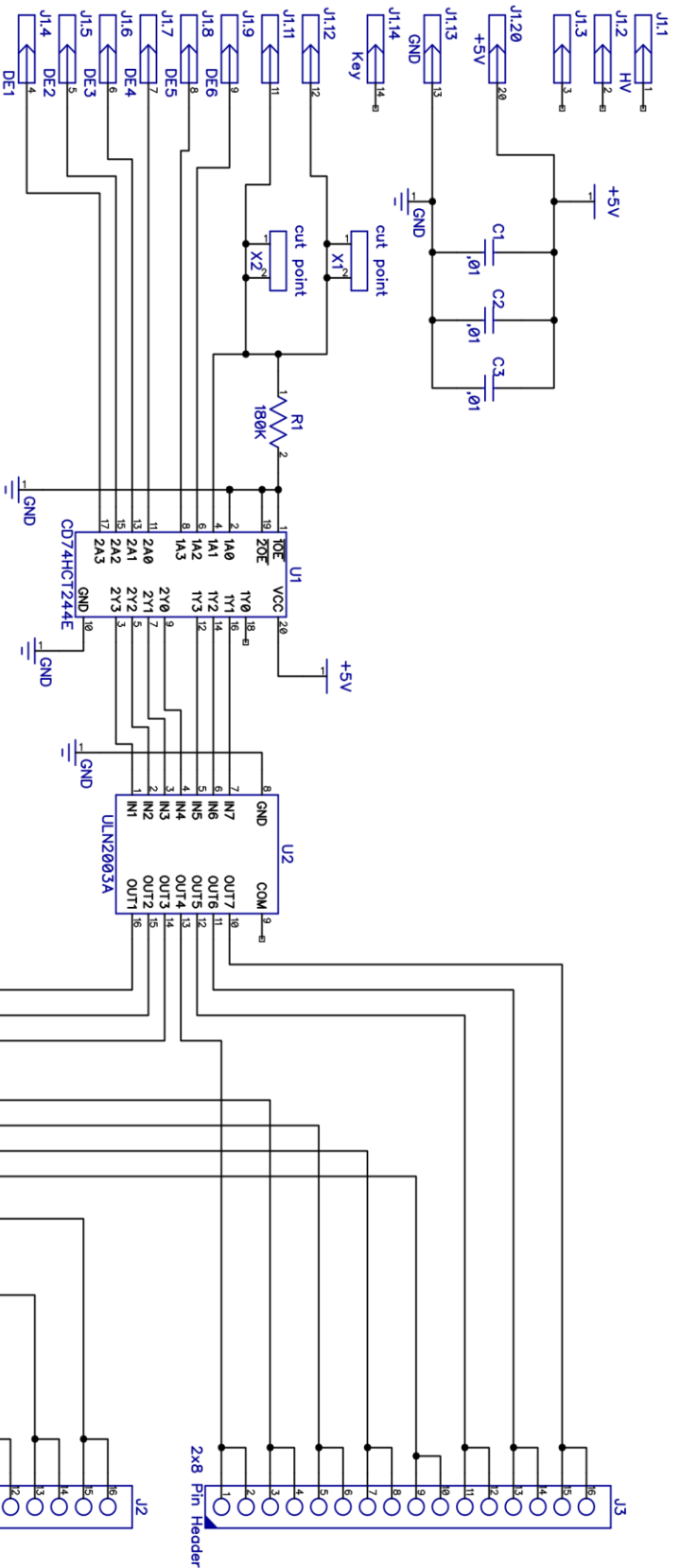

Rev 1 | PN 1980 Bally Universal CC Driver | Date | Signature | Checked

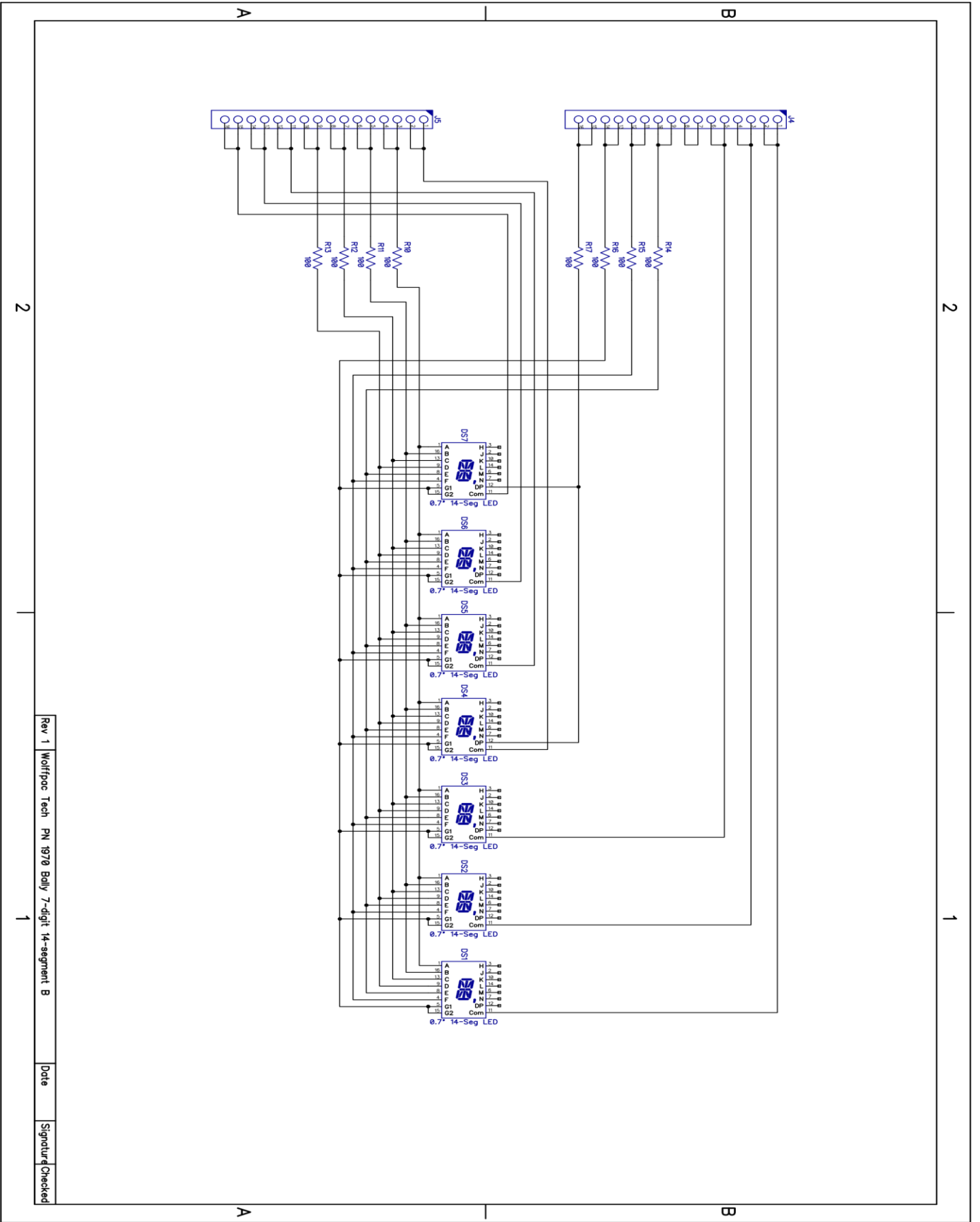

2

1

Rev 1 Wolfpoc Tech PN 1970 Bally 7-digit 14-segment B Date Signature/Checked